

BLIKIR RCP-2 can be used either as a carport or a backyard canopy. Made in the USA from galvanized steel and enhanced with special powder coating. It is a highly versatile and extremely easy to install system. It can be paired with any solar panel brand, and comes in dozens of different colors to match your exterior home and yard design, can be quickly installed by only two people and does not require the use of heavy machinery. All electrical wires can run in the columns.

USA

Made in the USA

A USA product, using US sourced steel.



Easy installation

Quickly installed with a 2-person crew.



25 Year Warranty

Products guaranteed to be free of impairing defects.



Light Tools

Installation doesn't require any heavy machinery.



Sturdy Design

Made from galvanized steel, durable design.



Versatile

Compatible with any solar panel. Available in various colors.







Tilt ● 5° Tilt

Loads ● 35 PSF Snow Load (High Snow 65 PSF option available)
● 175MPH Wind Load

Piers ● Requires 4 piers
● Pier depth only 2'

Racking ● Sealed Surface (no top clamps) - optional T-Gasket
● Integrated Grounding

Available Colors ● Default Color: Black 
● Galvanized & can be painted in any color    

Panels Uses either 60 or 72 cell solar panels:
● 24 x 60/120 cell panels (9.6kW @ 400W)
● 18 x 72/144 cell panels (9.9kW @ 550W)

Optional Add-Ons ● Tandem – connect multiple structures with shared columns
● Mesh cover - hides solar equipment, for cleaner look
● Column safety Solar LED lights
● Enel X EV Car Chargers - for residential and commercial

Drawings

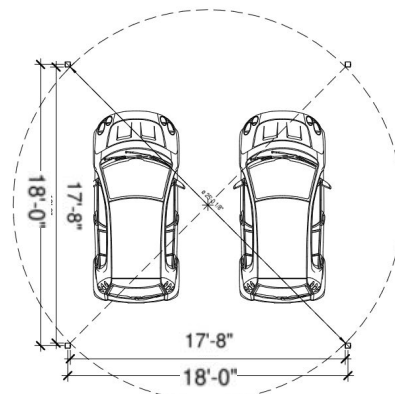
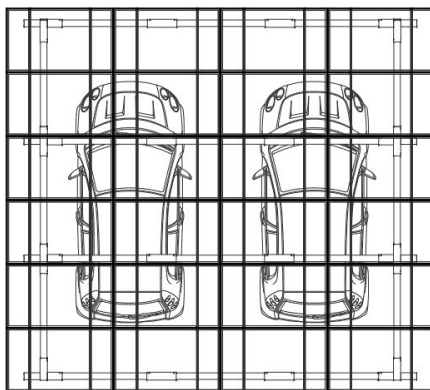
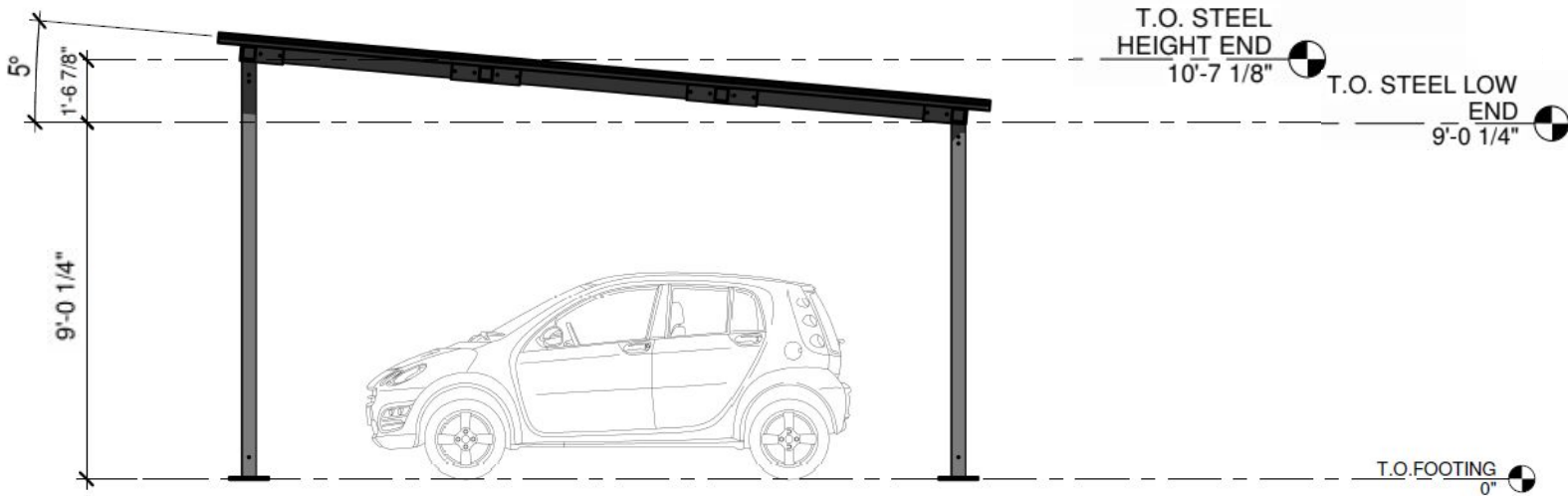
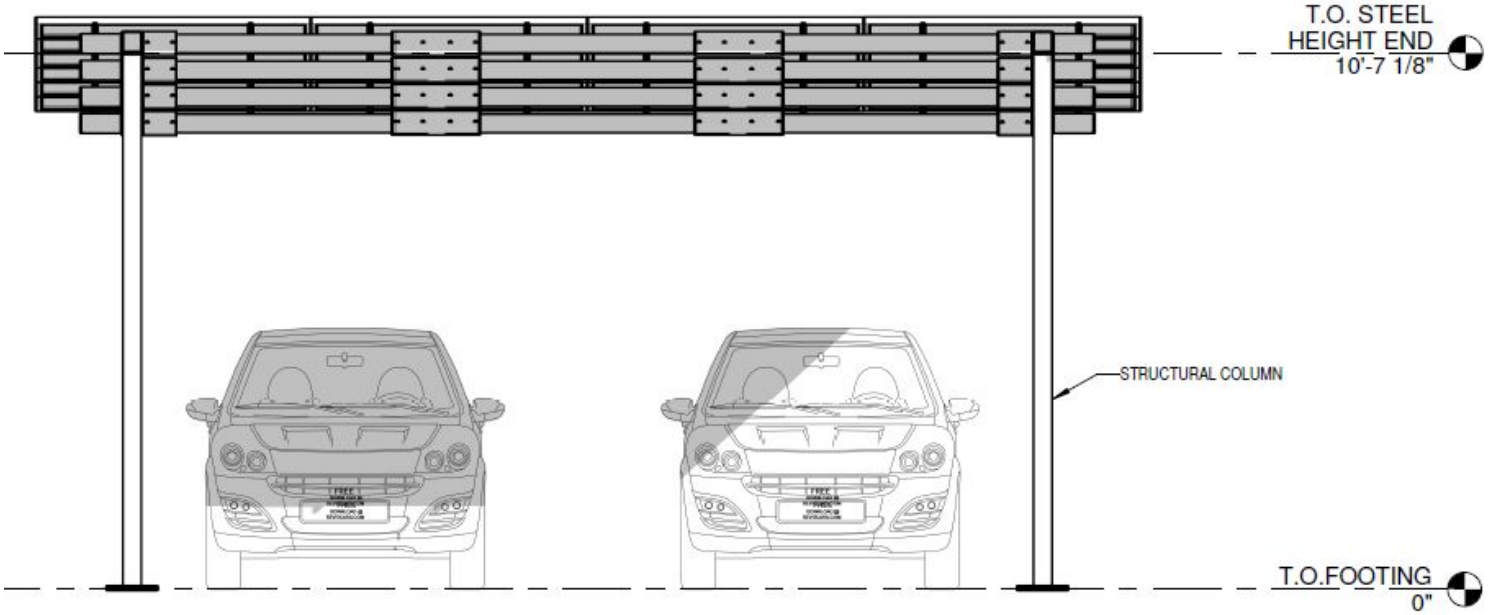

Optional Accessories



BLIKIR RCP-2 Solar Array Decorative Mesh

Use the decorative mesh to hide the solar array wiring, inverters and rails. This mesh will make your BLIKIR Carport or Canopy even more appealing than it already is! Side mesh is also available. All attachment accessories are included.



BLIKIR Panels Gap EPDM T Gasket Seal Strip 180 Feet

Install the gasket between the panels frames on the BLIKIR Carport/Canopy to create a watertight surface.



BLIKIR Column Solar LED Light with Movement Sensor

Install these solar lights on the front columns of your BLIKIR Solar Carport to help you notice the columns at night when you are parking your car. No wiring is required. Only attach it to the column with the included 3M adhesive and you are ready to park.



Enel X JuiceBox 48 Level-2 EV Charger

WiFi-enabled 48-amp smart EV charging station (Level 2 EVSE) with 25-foot cable & integrated cable management, hardwired installation

Authorized Installer: